

i-LIMB ORDER FORM QUANTUM | ULTRA | ACCESS

Customer: _____ Acc No: _____ Date: _____
 Contact Person: _____ Contact No: _____
 Patient Identifier: _____
 Return E-mail Address: _____

Choose hand type

Quantum Ultra Access

Choose hand side

Left Right

Choose wrist type

Quick Wrist
Disconnect(QWD)



Wrist Disarticulation
(WD)

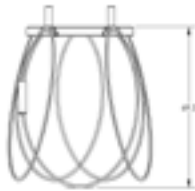

Flexion

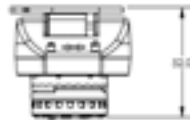

Friction



i-Limb Wrist(only available for hand connection QWD and Flexion)



Choose hand size

Extra small

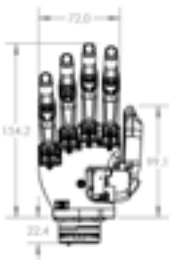

Small

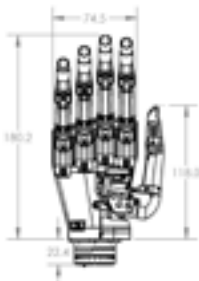

Medium

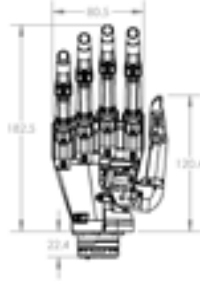

Large

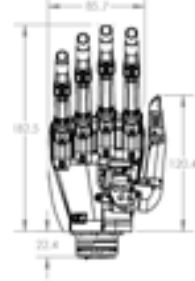

Extra option

Titanium Strengthened Fingers
(sold separately) Available in S/M/L



Choose package

Tick the box of the pack chosen.

Note: for Ultra and Access, only packs PK1 and PK2 available.

	PK1	PK2	PK3	PK4	PK5	PK6
Electrode kit	•	•	•	•	•	•
Socket component kit*	•	•	•	•	•	•
Battery and charger	•	•	•	•	•	•
iPod Touch	• (not with i-Limb Access)	• (not with i-Limb Access)	•	•	•	•
Grip Chips			•	•	•	•
Hand connection type	QWD or WD or Friction wrist	Flexion wrist	QWD or WD or Friction wrist	Flexion wrist	QWD or WD or Friction wrist	Flexion wrist
Compatible i-Limb Wrist(to be ordered searately w/additional cost)	• (with QWD only)	•	• (with QWD only)	•	• (with QWD only)	•
i-Limb Skin Coverings	6 pcs**	6 pcs**	6 pcs**	6 pcs**	4 pcs**	4 pcs**
i-Limb Skin Match Coverings					• (2 pcs)	• (2 pcs)

*For Flexion Wrist and Quick Wrist Disconnect incl. coaxial connector, coupling insert and lamination ring; for Friction Wrist and Wrist Disarticulation incl. switch block

**Choose from i-Limb Skin Active / TS, i-Limb Skin Contour / TS or i-Limb Skin Natural (maximum of 4 covers of the same type)

i-LIMB ORDER FORM QUANTUM | ULTRA | ACCESS

Choose Hand Covering Selection

Please enter the number of gloves desired, based on the i-Limb package selected:

i-Limb Skin Active

___ x Black ___ x Clear

i-Limb Skin Active TS

___ x Black ___ x Clear

i-Limb Skin Contour

___ x Black ___ x Clear

i-Limb Skin Contour TS

___ x Black ___ x Clear

i-Limb Skin Natural glove (color tones from 1 to 18)*

Please enter the number of gloves desired, based on the i-Limb package selected:

___ x color 1 ___ x color 2 ___ x color 3 ___ x color 4
 ___ x color 5 ___ x color 6 ___ x color 7 ___ x color 8
 ___ x color 9 ___ x color 10 ___ x color 11 ___ x color 12
 ___ x color 13 ___ x color 14 ___ x color 15 ___ x color 16
 ___ x color 17 ___ x color 18

*If required, a free color sample set can be sent.

Choose Electrodes

Electrodes

Remote (50Hz) Length(A)* 300mm 600mm
(2 pcs) Hertz*



Compact (50Hz) Length(A)* 300mm 600mm
(2 pcs) Hertz*



*Does not apply if hand is ordered with the i-Limb Wrist

Additional accessories(sold separately)

Toolkit T6
 Toolkit T8
 Toolkit T10
 iPod Touch

Quick Wrist Disconnect (QWD) Disengage Tool
 Grip Chip starter kit (1-10) (i-Limb Quantum only)
 Set of colour swatches

Choose Forearm Sleeve (Sold separately)

Choose size (only one size selectable)

XS S M L

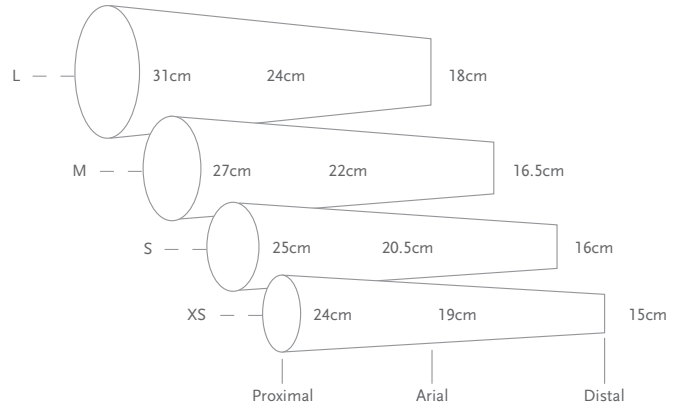

All covers have an average length of 35cm.

i-Limb Skin Natural forearm sleeve (only one color selectable)*

1	2	3	4	5	6
7	8	9	10	11	12
13	14	15	16	17	18

*If required, a free color sample set can be sent.

i-Limb Skin Match forearm sleeve*

i-Limb Skin Match forearm sleeve (individually)

* For this please send us a cast of the socket

Choose a battery

1300mAh with magnetic charger
 2000mAh with magnetic charger
 800mAh power pack

Choose a Wall Charger

Australia	Europe
UK	USA
South Africa	

Choose warranty - Touch Care Coverage Extension(sold separately)

i-Limb hand and o-Limb Wrist include a 2-year warranty.
 You can extend this warranty up to 5 years.

i-Limb hand	i-Limb Wrist
Year 3	Year 3
Year 4	Year 4
Year 5	Year 5