

FLEX-FOOT ASSURE®

UNITY
COMPATIBLE



The Flex-Foot Assure is best suited as a first prosthesis or a more permanent option for the less active.

Designed specifically for slower speed walkers, Flex-Foot Assure incorporates an active heel combined with the full-length keel that work together to protect the vulnerable sound limb.

Unity for Flex-Foot Assure is a sleeveless vacuum suspension system designed to stabilise volume fluctuations and maintain comfortable socket fit throughout the day. It is specifically designed for the low to moderate active user and in combination with Seal-In technology, it provides secure suspension and volume management. The lightweight foot incorporates an active heel combined with the full-length keel that work together to protect the vulnerable sound limb. The proven design and simple fit of Assure allows basic ambulators to take advantage of premium technology just right for them without the restricting effect of an external suspension sleeve. Unity adds minimal weight, no extra build height to the prosthesis and does not interfere with the foot module dynamics.



ÖSSUR FEET

User information	
Amputation Level:	Transfemoral and Transtibial
Impact Level:	Low
Maximum Patient Weight:	136kg (300lbs)



FULL LENGTH
TOE LEVER



ACTIVE TIBIAL
PROGRESSION



WATERPROOF*



WEATHERPROOF**

* Flex-Foot Assure with glass tube

** Flex-Foot Assure with pyramid

Foot Information	
Categories:	1-5
Sizes:	19-30
Weight of Foot: (Size 27)	544g (19.2oz) w/ Pyramid and Foot Cover
Build Height: (Size 27)	125mm (4 15/16") w/ Pyramid and Foot Cover
Heel Height:	10mm (3/8")
Adapter Options:	Male Pyramid or Fiberglass Tube

Unity System Information	
Foot Sizes:	22-30
Maximum Vacuum:	-23inHg (-600mmHg)
Normal Operating Pressure:	-15-18 inHg
Added System Weight:	104g w/ Pump, Socket Valve and Tube

FLEX-FOOT ASSURE®

ORDERING INFORMATION

FOR COMPLETE FOOT

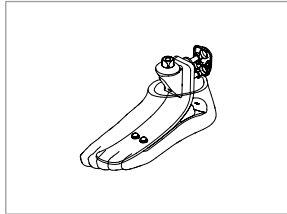

FOR COMPLETE FOOT WITH TUBE

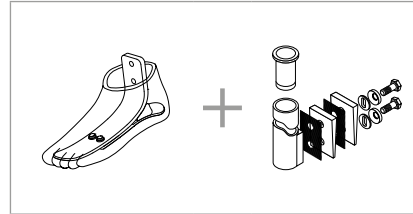

Please select the appropriate Unity Pump Module kit according to foot module size when placing an order and Unity will come preassembled on the foot. For extra convenience and system compatibility, Unity Valve Kits are highly recommended as a means of connecting to the socket.

For liner selection charts and item numbers please refer to the appropriate Iceross Seal-In page.

FOR COMPLETE FOOT

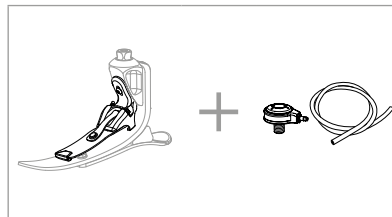

CATEGORY SELECTION CHART

Weight kg	45-61	62-80	81-97	98-114	115-136
Weight lbs	99-135	136-176	177-214	215-251	252-300
19-20**	1	2	N/A	N/A	N/A
21-22**	1	2	N/A	N/A	N/A
23-24	1	2	3	4	N/A
25-26	1	2	3	4	5
27-28	1	2	3	4	5
29-30	N/A	2	3	4	5

NOTE: The above categories apply only to Flex-Foot Assure

*All sizes not available for each category

**Unity for Flex-Foot Assure is available from sizes 22 and in all categories.

FLEX-FOOT ASSURE®

CLEARANCE

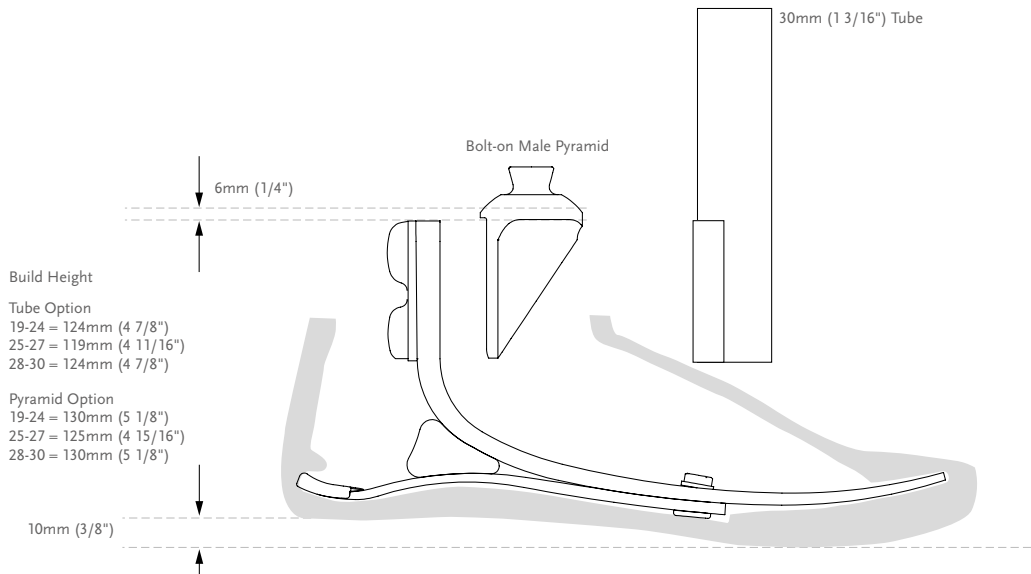

*Note: Flex-Foot Assure with Unity has the same build height as Flex Foot Assure with a Pyramid Option.

KITS

FLEX-FOOT ASSURE KIT WITH MALE PYRAMID

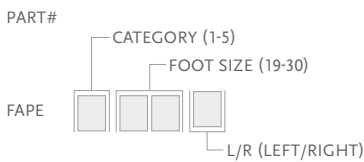

- Includes:
- Foot Module with Male Pyramid
 - Foot Cover Kit*

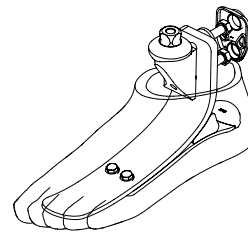

*For Flex-Foot Assure with brown foot cover, add "BR" to the part#.

FLEX-FOOT ASSURE KIT WITHOUT ADAPTER

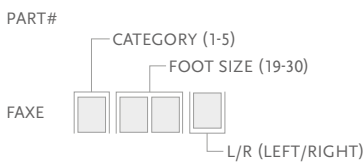

- Includes:
- Foot Module
 - Foot Cover Kit*

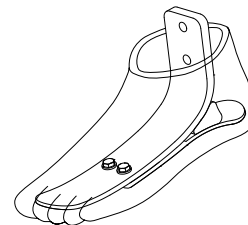

*For Flex-Foot Assure with brown foot cover, add "BR" to the part#.

FLEX-FOOT ASSURE®

COMPONENTS

MALE PYRAMID ADAPTER WITH BOLTS

Part#	Cat.	Weight	
SFX00165	ALL	158g	5.6oz



30MM FIBERGLASS TUBE KIT

Part#	Cat.	Wall	Thickness		Length		Weight	
SFX00001	Red	1-3	3mm	1/8"	279mm	11"	292g	10.3oz
SFX00002	Red	1-3	3mm	1/8"	381mm	15"	333g	11.7oz
SFX00003	Green	4-5	4mm	3/16"	279mm	11"	331g	11.7oz
SFX00004	Green	4-5	4mm	3/16"	381mm	15"	401g	14oz

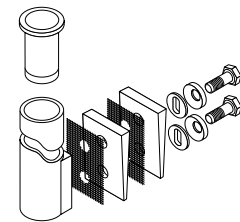

Includes:

- Tube Insert (cat. 4-5)
- Bolts (5/16" UNF)
- Spherical Washers
- Friction Pads
- Loctite 410
- Alignment Wedges

FOOT KITS WITH UNITY

FLEX-FOOT ASSURE WITH MALE PYRAMID AND UNITY PUMP

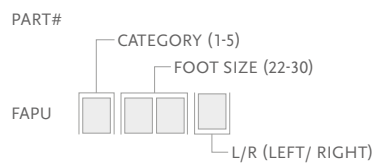

Includes:

- Foot Module with Male Pyramid
- Foot Cover Kit*
- Unity Pump

*For Flex-Foot Assure with brown foot cover, add "BR" to the part#.

Note: Unity pump will come preassembled on the foot. Valve kit needs to be ordered separately.

FLEX-FOOT ASSURE®

UNITY

UNITY KITS

Picture	Part#	Description	Applicable Foot Kits
1	UFA0024	FAP-JBP Unity Pump S22-24	Flex-Foot Assure Size 22-24
1	UFA0027	FAP-JBP Unity Pump S25-27	Flex-Foot Assure Size 25-27
1	UFA0030	FAP-JBP Unity Pump S28-30	Flex-Foot Assure Size 28-30
2	UTT0001	Unity TT Valve Kit	All
3	UTF0001	Unity TF Valve Kit	All
4	UTF0006	Unity TF Tube Kit	All
5	L-544611	Icelock 544 Kit Unity	All

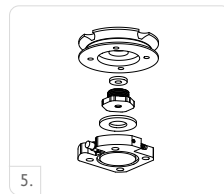
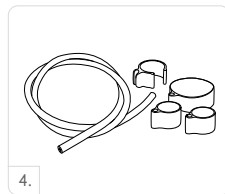

SPARE COMPONENTS

Part#	Description
UFA00021	Unity FAP-JBP Components 22-24
UFA00022	Unity FAP-JBP Components 25-27
UFA00023	Unity FAP-JBP Components 28-30

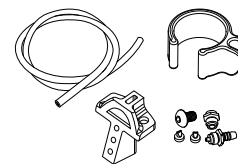

Includes:

- Pump Blade
- Membrane
- Barb Fittings
- Check valves
- Mounting Screw
- Tube
- Loctite
- Tube clamp

COSMETIC FINISHING

FOOT COVER KIT, BEIGE AND BROWN*

PART#

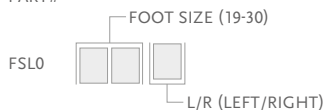

Includes:

- Foot Cover Kit
- Foot Cover Attachment

*For Flex-Foot Assure with brown foot cover, add "BR" to the part#.

FLEX-FOOT ASSURE®

COSMETIC FINISHING

FLEX-FOOT SOCKS

Used to cover the composite foot module to protect the foot and eliminate noise between foot module and foot shell.

Part#	Description	Size	Colour
FCX63022	FF Sock Small 1 pc	19-25	Black
FCX63025	FF Sock Large 1 pc	26-30	Black
FCX63022-15	FF Sock Small 15 pcs	22-25	Black
FCX63026-15	FF Sock Large 15 pcs	26-30	Black



DIAGRAM

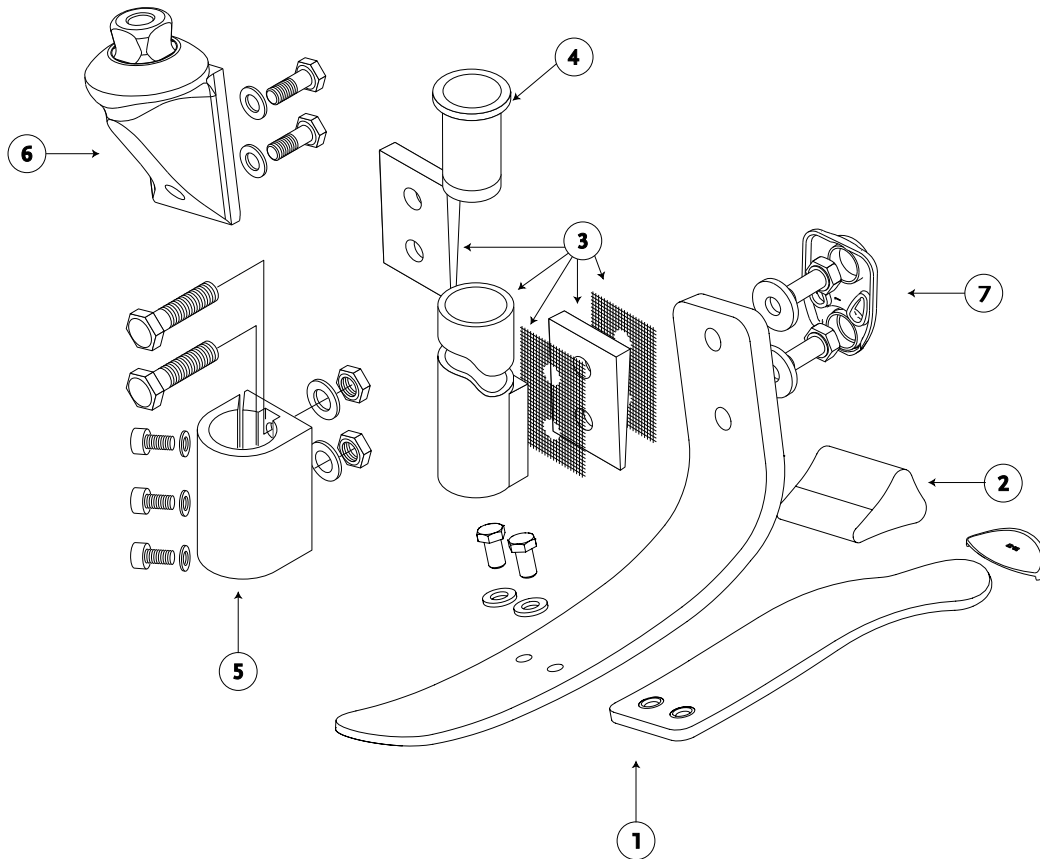

	Description
1.	Foot Module
2.	Foam Wedge
3.	30mm (1 3/16") Fiberglass Tube Kit
4.	Tube Insert for SF5-SF6
5.	30mm (1 3/16") Alignment Fitting Tool
6.	Male Pyramid
7.	Attachment Bolts