

## RE-FLEX SHOCK™

UNITY  
COMPATIBLE



Re-Flex Shock offers the best vertical shock absorption of all the Össur mechanical feet. With dynamic energy return and all around responsiveness the foot is a great choice for active users.

The composite spring in front provides shock absorption that reduces impact subjected to the body. Enhancing both control and comfort during walking and other activities.

The Unity vacuum suspension system is available as an addition to the Re-Flex Shock™ foot module. Unity in combination with Iceross Seal-In technology provides elevated vacuum in the socket during ambulation, without the restricting effect of an external sealing sleeve. Unity adds minimal weight to the existing prosthesis and does not interfere with the function of Re-Flex foot and shock modules.



User Information	
Amputation Level:	Transfemoral and Transtibial
Impact Level:	Low to High
Maximum Patient Weight:	166kg (365lbs)



WEATHERPROOF



ACTIVE TIBIAL PROGRESSION



VERTICAL SHOCK PYLON



SPLIT TOE

Foot Information	
Categories:	1-9
Sizes:	22-30
Weight of Foot: (Size 27)	1076g (38 oz) w/ foot cover and sock
Build Height Standard: (Size 27)	210-238mm (8 1/4" - 9 3/8") w/ Foot Cover and Male Pyramid
Build Height Tall: (Size 27)	255-288mm (10 1/16" - 11 5/16") w/ Foot Cover and Male Pyramid
Heel Height:	10mm (3/8"), 19mm (3/4") available on special order
Adapter:	Male Pyramid

Unity System Information	
Maximum Vacuum:	23inHg (600mmHg)
Normal Operating Pressure:	-16inHg to -20inHg
Added System Weight:	130g w/ Pump, Socket Valve and Tube

# RE-FLEX SHOCK™

## ORDERING INFORMATION

FOR COMPLETE FOOT\*



Unity can be ordered with Re-Flex Shock in the standard foot module height. Please select the appropriate Unity Pump Module kit according to foot module size when placing an order and Unity will come preassembled on the foot. For extra convenience and system compatibility, Unity Valve Kits are highly recommended as a means of connecting to the socket.

For liner selection and item numbers please refer to Icross Seal-In V and Seal-In® X TF pages.

FOR COMPLETE FOOT WITH UNITY

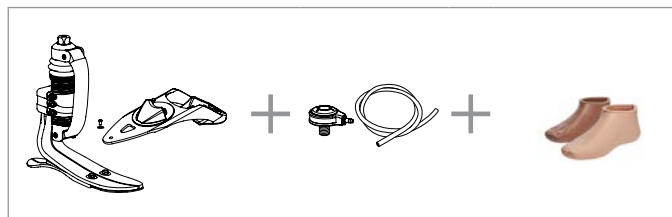

\*Foot module also available in tall profile

## CATEGORY SELECTION CHART

Weight kg	45-52	53-59	60-68	69-77	78-88	89-100	101-116	117-130	131-147	148 - 166
Weight lbs	99-115	116-130	131-150	151-170	171-194	195-220	221-256	257-287	288-324	325-366

### Low Impact Category

Size 22-24	1	1	2	3	4	5	6	N/A	N/A	N/A
Size 25-27	1	1	2	3	4	5	6	7	8	9
Size 28-30	3	3	3	3	4	5	6	7	8	9

### Moderate Impact Category

Size 22-24	1	2	3	4	6	6	N/A	N/A	N/A	N/A
Size 25-27	1	2	3	4	5	6	7	8	9	N/A
Size 28-30	3	3	3	4	5	6	7	8	9	N/A

### High Impact Category

Size 22-24	2	3	4	5	6	N/A	N/A	N/A	N/A	N/A
Size 25-27	2	3	4	5	6	7	8	9	N/A	N/A
Size 28-30	3	3	4	5	6	7	8	9	N/A	N/A

# RE-FLEX SHOCK™

## CLEARANCE

### RE-FLEX SHOCK STANDARD FOOT MODULE

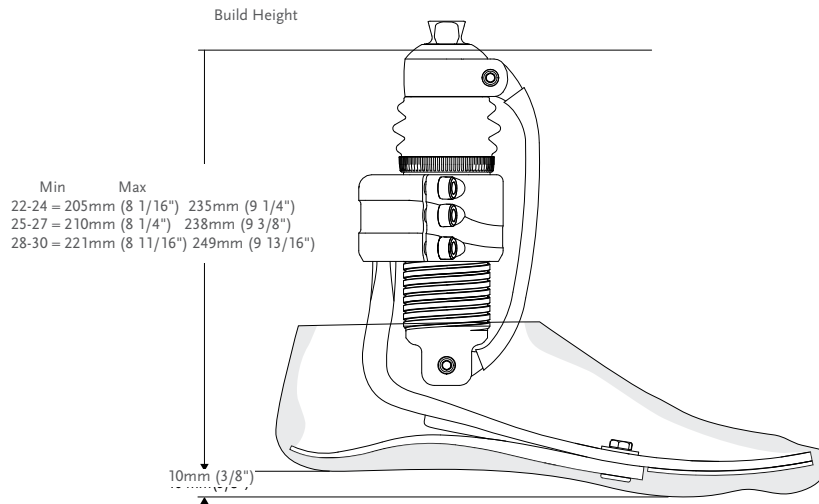

### RE-FLEX SHOCK TALL FOOT MODULE

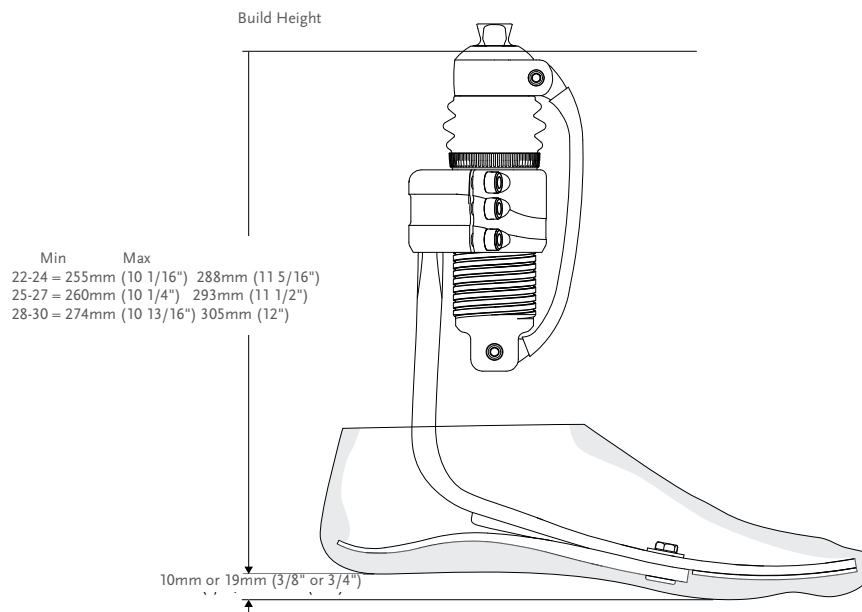

\*Note: Re-Flex Shock with Unity has the same build height as Re-Flex Shock.

# RE-FLEX SHOCK™

## KITS

### STANDARD PROFILE WITH SHOCK

MALE PYRAMID ATTACHMENT

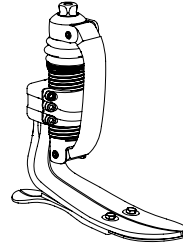
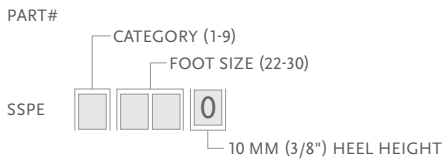

### TALL PROFILE WITH SHOCK

MALE PYRAMID ATTACHMENT

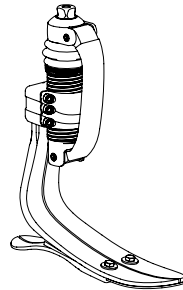
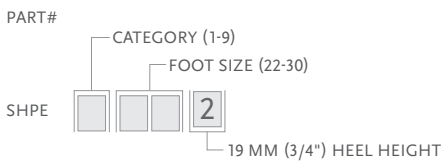
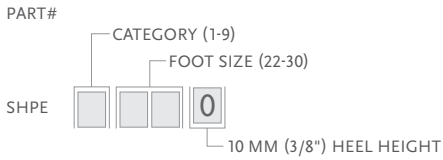

Includes:

- Foot Module
- Shock Module with Carbon Front Spring
- Heel Wedges

Shock Kit Includes:

- Male Pyramid Shock Module
- Loctite

Note:

- 19mm (3/4") heel are special orders.
- Solid toe is a special order.

### STANDARD PROFILE WITHOUT SHOCK

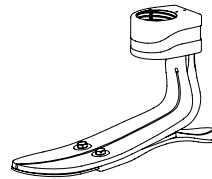
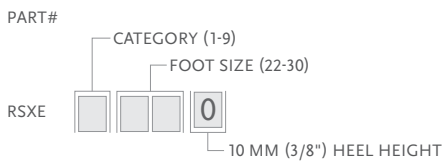

Note: 19mm heel height for standard profile, foot size 25-30, available upon special order.

# RE-FLEX SHOCK™

## KITS

### TALL PROFILE WITHOUT SHOCK

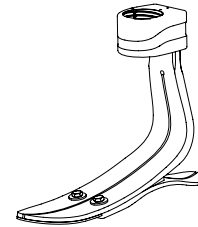
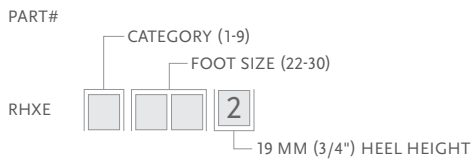
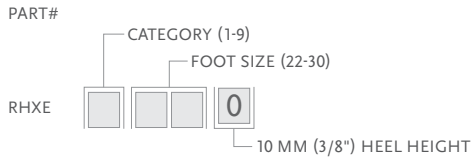

Includes:

- Foot Module

Note:

- 19mm (3/4") heel are special orders.
- Solid toe is a special order.

### SHOCK KITS

#### MALE SHOCK KIT

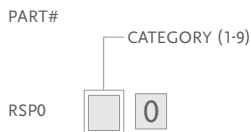

## COMPONENTS

### HEEL WEDGE KITS

Tall and Standard Profile Foot Module	Foot Size	Cat.
CM150011	22-30	ALL

Includes:

- 3 Wedges
- Adhesive



Part#	Description
CM160025	Loctite 243

# RE-FLEX SHOCK™

## COMPONENTS

### FRONT SPRINGS

Part#	Cat.
RSS44001	1
RSS44002	2
RSS44003	3
RSS44004	4
RSS44005	5
RSS44006	6
RSS44007	7
RSS44008	8

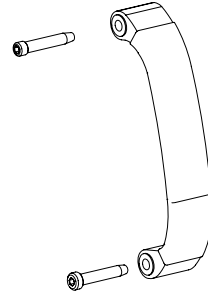

Includes:

- Front Spring
- 2 Pins

### BUSHING KIT

Part#	Description
RSS00001	Bushing Kit

Includes:

- 4 Bushings
- 4 Disc Springs
- 2 Pins

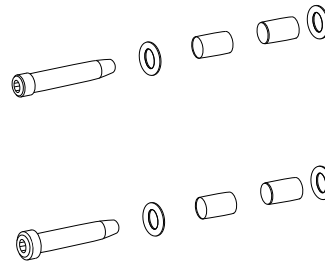

### LOWER RING

Part#	Description
RSS40011	Re-Flex Shock Bellow
RSS40012	Re-Flex Shock Collar

## TOOLS

### TORQUE WRENCH

Part#	Description
FFC7980001	Torque Wrench 3Nm Preset

# RE-FLEX SHOCK™

## FOOT KITS WITH UNITY

### RE-FLEX SHOCK™ STANDARD PROFILE WITH UNITY PUMP

#### MALE PYRAMID ATTACHMENT

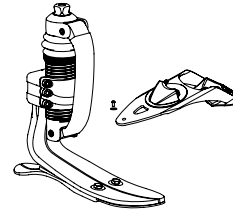

Caution: Due to restricted space with the Re-Flex Shock shock module and Unity, SSPE® kits allow for only 2 full turns of downwards adjustment from the tallest setting. Re-Flex Rotate modules can be set to any height within their designed limits.

Note: Unity pump will come preassembled on the foot. Valve kit needs to be ordered separately.

## UNITY

### UNITY KITS

Picture	Part#	Description	Applicable Foot Kits
1	UTT0001	Unity TT Valve Kit	All
2	UTF0001	Unity TF Valve Kit	All
3	UTF0006	Unity TF Tube Kit	All
4	L-544611	Icelock 544 Kit	All
5	UTT1103	Unity Valve Air Filter Pack (10 p.)	All

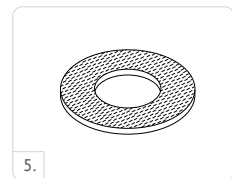
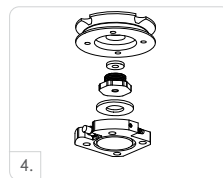
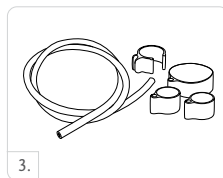

## UNITY SPARE COMPONENTS

Part#	Description
URS00021	Unity RS Components, 22-24
URS00022	Unity RS Components, 25-30

Includes:

- Membrane
- Check valves
- Barb fittings
- Tube
- Tube fastener
- Heel pad

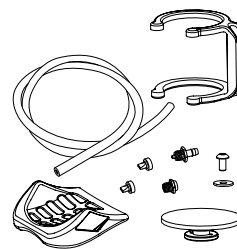

# RE-FLEX SHOCK™

## COSMETIC FINISHING

### FOOT COVER KIT, BEIGE AND BROWN\*

PART#

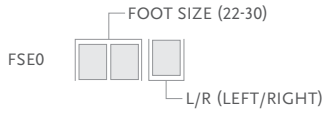

Includes:

- Foot Cover
- Flex-Foot Sock
- Foot Cover Attachment

\*Please specify when ordering brown covers, add "BR" to the end of the part number.

### SPECTRA SOCKS

Used to cover the composite foot module to protect the foot and eliminate noise between foot module and foot shell.

Part#	Description	Size	Color
FSEL60001	Black Sock Small 1 pc	22-25	Black
FSEL60002	Black Sock Large 1 pc	26-30	Black
FSEL60001-15	Black Sock Small 15 pc	22-25	Black
FSEL60002-15	Black Sock Large 15 pc	26-30	Black





# RE-FLEX SHOCK™

## DIAGRAM

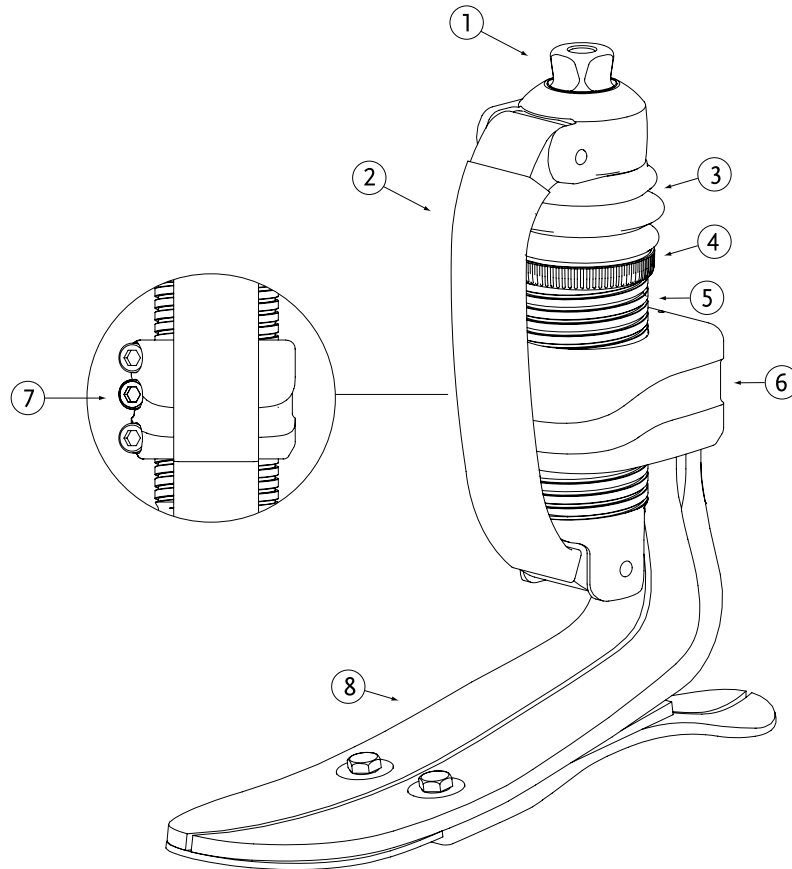

	Description
1.	Male Pyramid
2.	Front Spring
3.	Bellow
4.	Collar
5.	Threaded Outer Tube
6.	Fixed Attachment Clamp
7.	Attachment Clamp Screws
8.	Foot Module