

Order Form

i-Limb® Quantum | i-Limb® Ultra | i-Limb® Access

Company information (billing)

Clinician name: _____
 Company name: _____
 Company address: _____

 Country: _____
 Telephone: _____
 Purchase order #: _____
 Sales quotation #: _____

Tick if shipping is the same as billing address

Ship to address: _____

Ship via: _____ Customer carrier Össur carrier

Please provide email address for order confirmation:

Patient information

Patient identifier: _____

Choose hand type

Quantum Ultra Access

Choose hand side

Left Right

Choose hand connection type

Quick Wrist Disconnect (QWD) Wrist Disarticulation (WD) Flexion Friction

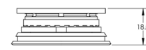
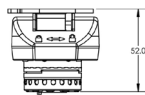
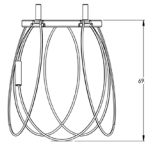
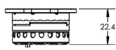

Extra Options (sold separately)

Titanium Strengthened Fingers (Included with i-Limb Quantum & i-Limb Ultra)
 Available in S/M/L



Choose hand size

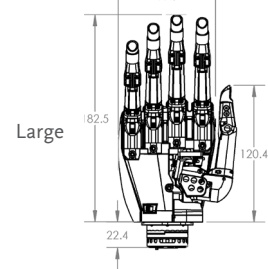
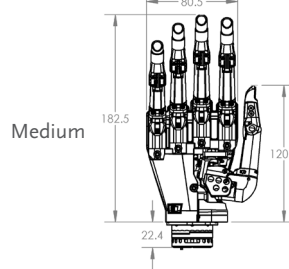
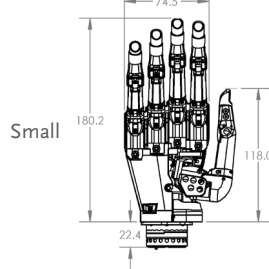
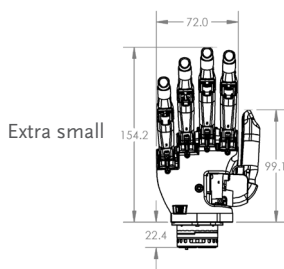

Choose package

Tick the box of the pack chosen.

Note: for Ultra and Access, only packs PK1 and PK2 available.

	PK1	PK2	PK3	PK4	PK5	PK6
i-Limb Quantum Titanium	TBX50140	TBX50141	TBX50142	TBX50143	TBX50144	TBX50145
i-Limb Ultra Titanium	TBX50185	TBX50186				
i-Limb Access Std	TBX50042	TBX50043				
i-Limb Access Titanium	TBX50484	TBX50485				
Electrode kit	•	•	•	•	•	•
Socket component kit*	•	•	•	•	•	•
Battery and charger	•	•	•	•	•	•
Grip chips			•	•	•	•
Hand connection type	QWD or WD or Friction wrist	Flexion wrist	QWD or WD or Friction wrist	Flexion wrist	QWD or WD or Friction wrist	Flexion wrist
Compatible i-Limb Wrist (to be ordered separately w/ additional cost)	• (with QWD only)	•	• (with QWD only)	•	• (with QWD only)	•
i-Limb Skin Coverings	6 pcs**	6 pcs**	6 pcs**	6 pcs**	4 pcs**	4 pcs**
i-Limb Skin Match coverings					• (2 pcs)	• (2 pcs)

*For Flexion Wrist and Quick Wrist Disconnect incl. coaxial connector, coupling insert and lamination ring ; for Friction Wrist and Wrist Disarticulation incl. switch block
 **Choose from i-Limb Skin Active/TS, i-Limb Skin Contour / TS or i-Limb Skin Natural (maximum of 4 covers of the same type)

i-Limb® Quantum | i-Limb® Ultra | i-Limb® Access

Choose Covering Selection

Please enter the number of gloves desired, based on the i-Limb package selected:

i-Limb Skin Active

___ x Black ___ x Clear

i-Limb Skin Active TS

___ x Black ___ x Clear

i-Limb Skin Contour

___ x Black ___ x Clear

i-Limb Skin Contour TS

___ x Black ___ x Clear

i-Limb Skin Natural glove (color tones from 1 to 18)*

Please enter the number of gloves desired, based on the i-Limb package selected:

___ x color 1 ___ x color 2 ___ x color 3 ___ x color 4
 ___ x color 5 ___ x color 6 ___ x color 7 ___ x color 8
 ___ x color 9 ___ x color 10 ___ x color 11 ___ x color 12
 ___ x color 13 ___ x color 14 ___ x color 15 ___ x color 16
 ___ x color 17 ___ x color 18

* If required, a free color sample set can be sent.

Forearm sleeve (sold separately)

Choose size (only one size selectable)

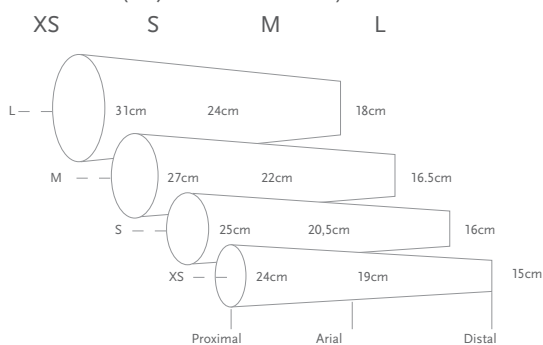

All covers have an average length of 35cm.

i-Limb Skin Natural forearm sleeve (only one color selectable)*

1	2	3	4	5	6
7	8	9	10	11	12
13	14	15	16	17	18

* If required, a free color sample set can be sent.

i-Limb Skin Match forearm sleeve*

i-Limb Skin Match forearm sleeve (individually)

* For this please send us a cast of the socket.

Choose Electrodes

Electrodes

Remote Length (A)*: 300mm 600mm
 (2 pcs) Hertz*: 50Hz (EU)



Compact Length*: 300mm 600mm
 (2 pcs) Hertz*: 50Hz (EU)



Additional accessories (sold separately)

- Toolkit T6
- Toolkit T8
- Toolkit T10
- Quick Wrist Disconnect (QWD) Disengage Tool
- Grip Chip starter kit (1-10) (i-Limb Quantum only)

Comments

Customer Signature

FOLLOW ÖSSUR ON



TEL + 46 18 18 22 00
 info@ossur.com

WWW.OSSUR.SE

